

HDL 26-A

Aktives 2-Wege-Line-Array-Modul

BESCHREIBUNG

Das RCF HDL 26-A ist ein sehr kompaktes, aktives 2-Wege-Touringsystem mit 2-Kanal-Endstufe für kleine und mittlere Veranstaltungen im Innen- und Außenbereich. Die fortschrittlichen Wandler und die 2000-Watt-Class-D-Endstufe – eine der besten ihrer Klasse – sorgen für einen erweiterten Low-mid Bereich und herausragenden Klang für viele Anwendungen, sei es als Stand-alone oder in einem größeren System via RDNet eingebunden.

Das Bass-Modul HDL 35-AS für geflogene Anwendungen passt ideal zum Line Array HDL 26-A.

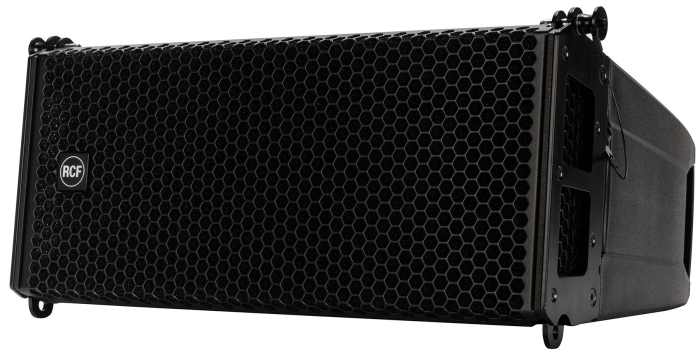

FUNKTIONEN

- 133 dB maximaler Schalldruckpegel
- 2-Kanal-Endstufe 2000 Watt
- Exklusive FiRPHASE-Technologie
- Trennfrequenz 750 Hz für optimale Stimmwiedergabe
- RDNet für netzwerkbasierendes Management
- 3-Zoll-Titanmembran-Kompressionstreiber
- 2 x 6-Zoll-Neodym-Hochleistungstieftöner
- 4PATH-Waveguide

SPEZIFIKATIONEN

| | | |
|-----------------------------|------------------------------|-------------------------|
| Spezifikation | Frequenzgang: | 55 Hz ÷ 20000 Hz |
| | Max SPL @ 1m: | 133 dB |
| | Horizontaler Abstrahlwinkel: | 100° |
| | Vertikaler Abstrahlwinkel: | 10° |
| Schallwandler | Kompressionstreiber: | 1 x 1.5" neo, 3.0" v.c |
| | Woofer: | 2 x 6.0" neo, 2.0" v.c |
| Input/Output sektion | Eingangssignal: | bal/unbal |
| | Eingangsbuchsen: | XLR, RDNet Ethercon |
| | Ausgangsanschlüsse: | XLR, RDNet Ethercon |
| | Eingangsempfindlichkeit: | +4 dBu |
| Prozessor | Übergangsfrequenz: | 750 |
| | Schutzschaltungen: | Thermal, RMS |
| | Limitier: | Soft Limiter |
| | Steuerung: | Preset, RDNet bypass |
| | RDNet: | Yes |
| Power sektion | Gesamtleistung: | 2000 W Peak, 1000 W RMS |
| | HF Bereich: | 600 W Peak, 300 W RMS |
| | Tiefe Frequenzen: | 1400 W Peak, 700 W RMS |
| | Kühlung: | Convection |
| | Verbindungen: | Powercon IN/OUT |
| Standardkonformität | CE Zeichen: | Yes |
| Physikalische daten | Gehäuse Material: | PP Composite |
| | Hardware: | Array fittings |
| | Griffe: | 2 Back |
| | Gitter: | Steel |
| | Farbe: | Black, White |
| Größe | Höhe: | 237 mm / 9.33 inches |
| | Breite: | 470 mm / 18.5 inches |
| | Tiefe: | 377 mm / 14.84 inches |
| | Gewicht: | 13.5 kg / 29.76 lbs |
| Versandinformationen | Verpackung Höhe: | 260 mm / 10.24 inches |
| | Verpackung Breite: | 550 mm / 21.65 inches |
| | Verpackung Tiefe: | 425 mm / 16.73 inches |
| | Verpackungsgewicht: | 14.9 kg / 32.85 lbs |



ARTIKEL-NUMMER

• **13000606**

HDL 26-A W

White

EAN 8024530017422

• **13000588**

HDL 26-A

Black

EAN 8024530016845

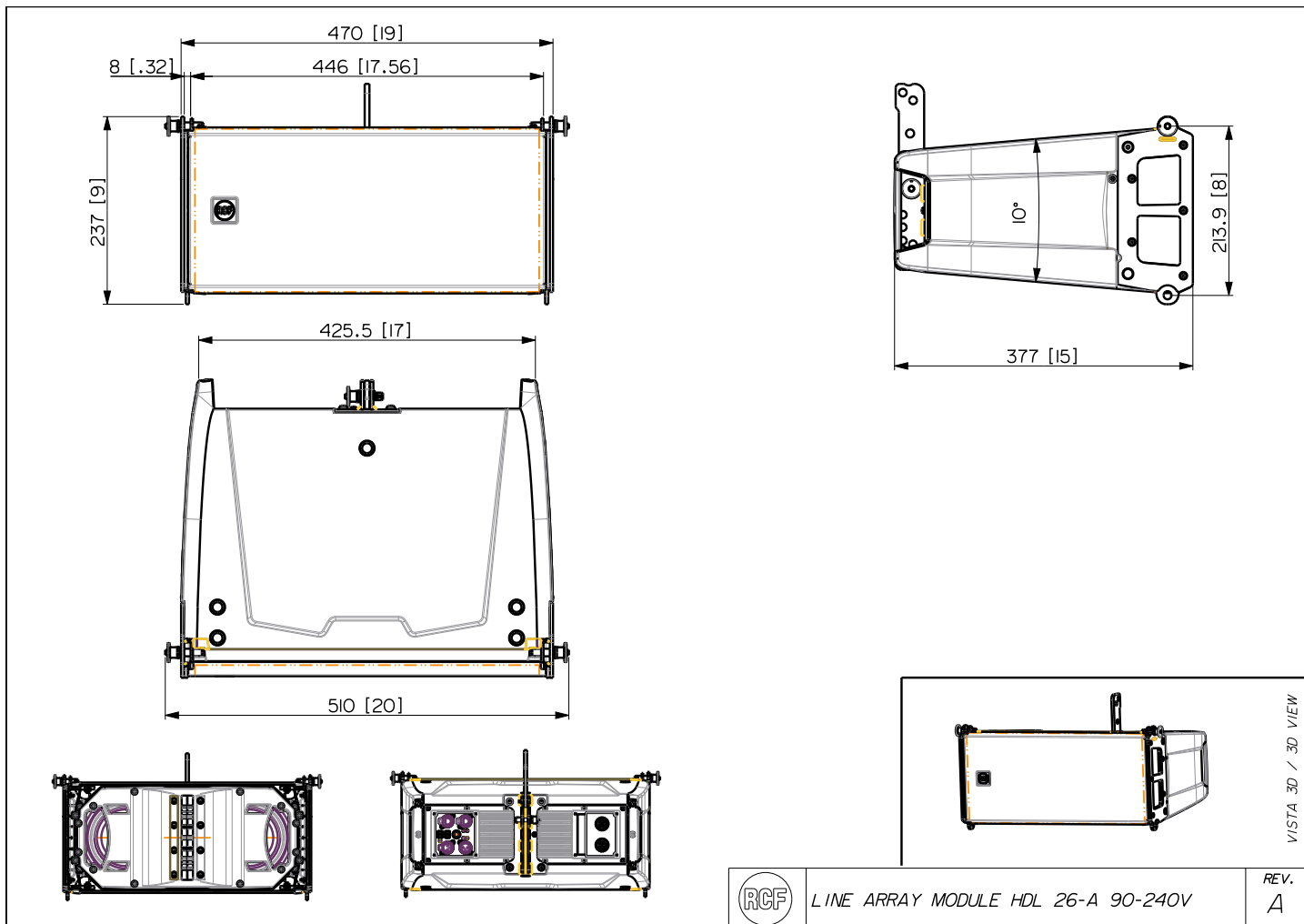

LINE ARRAY MODULE HDL 26-A 90-240V

REV.
A

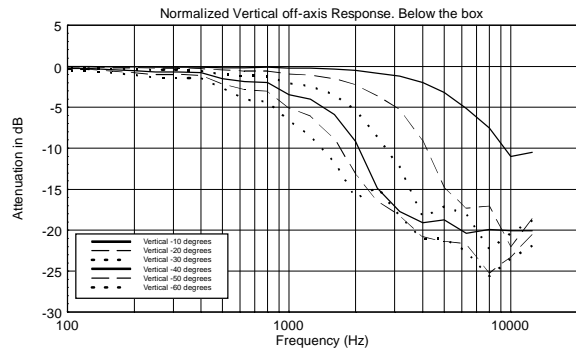
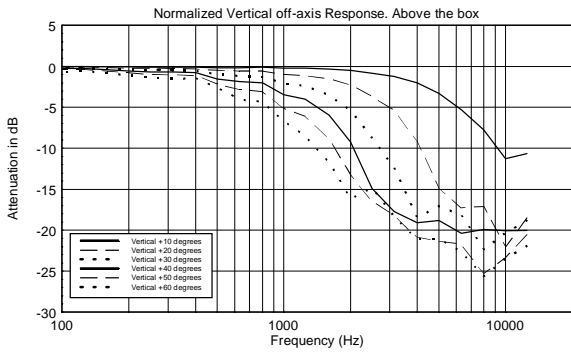
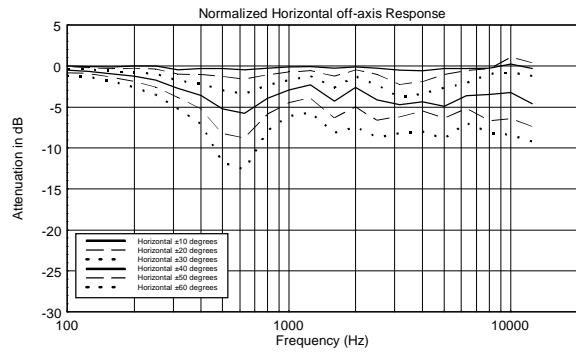
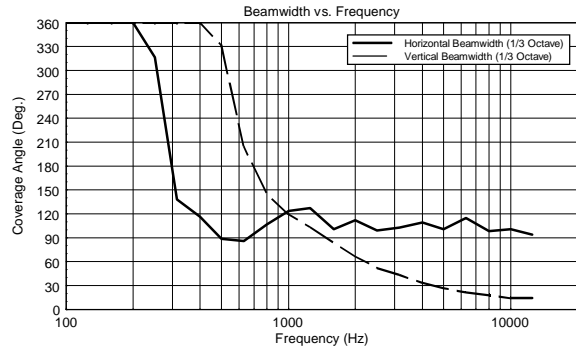
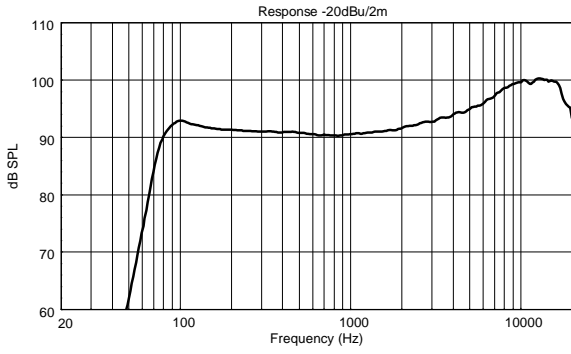

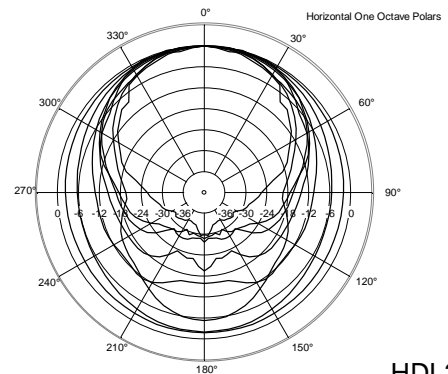
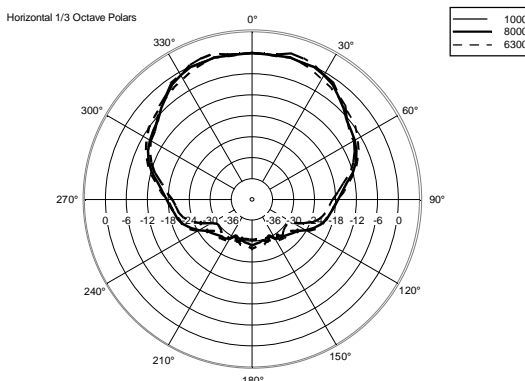
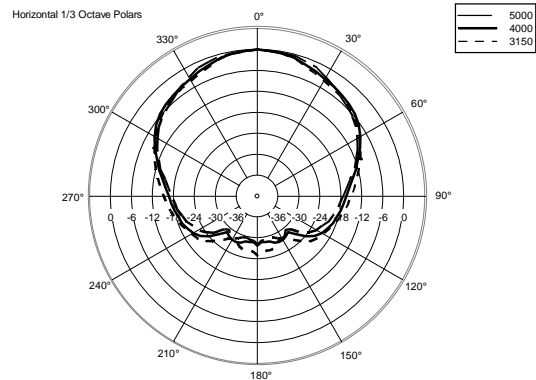
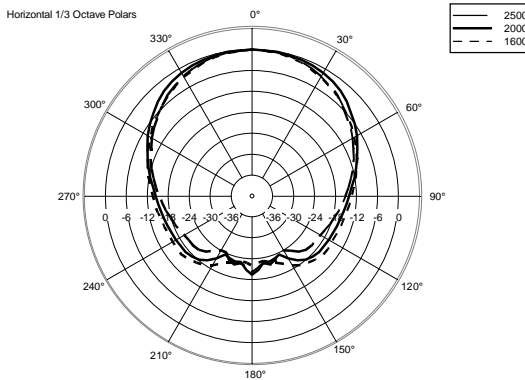
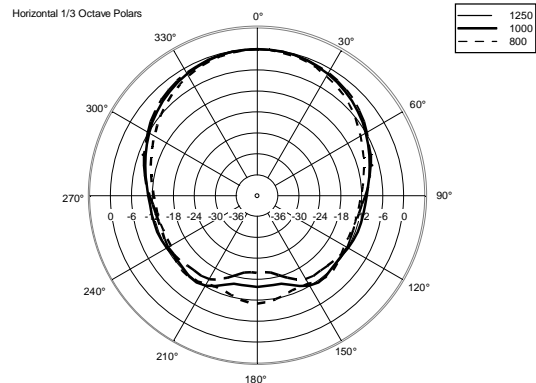
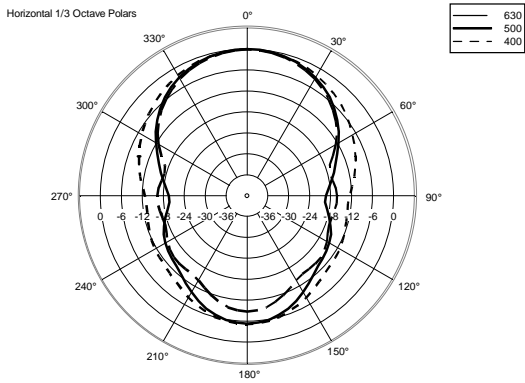
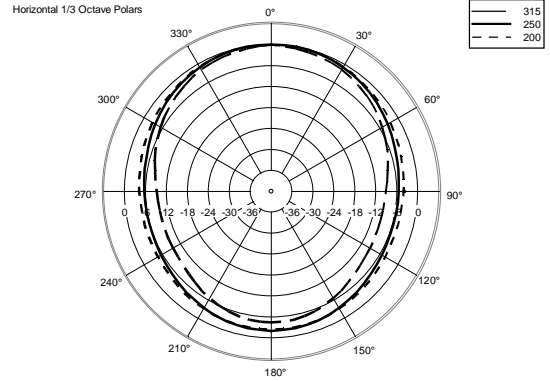
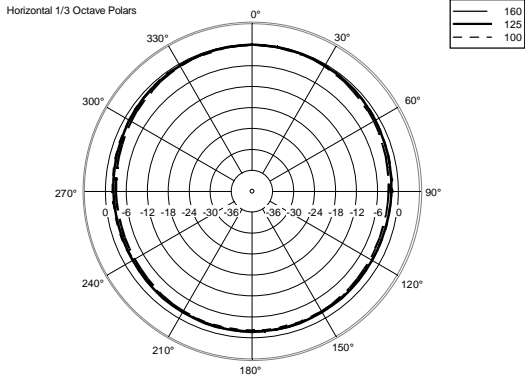

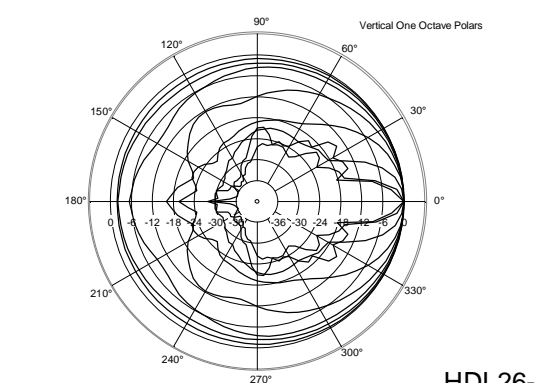
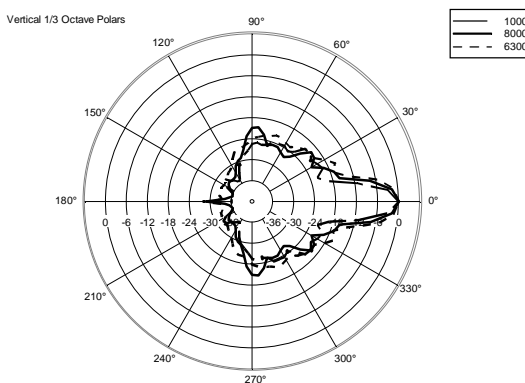
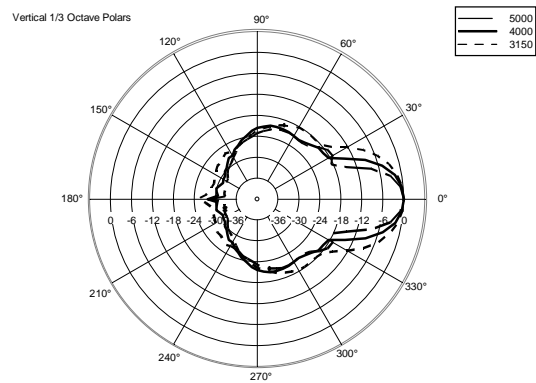
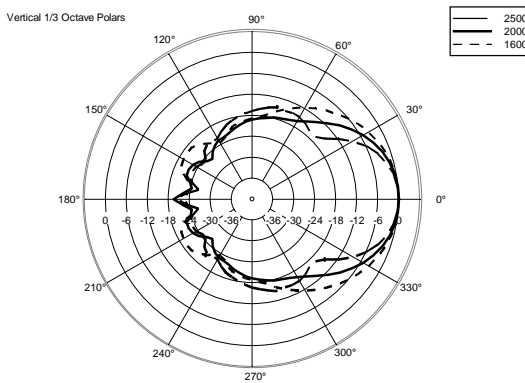
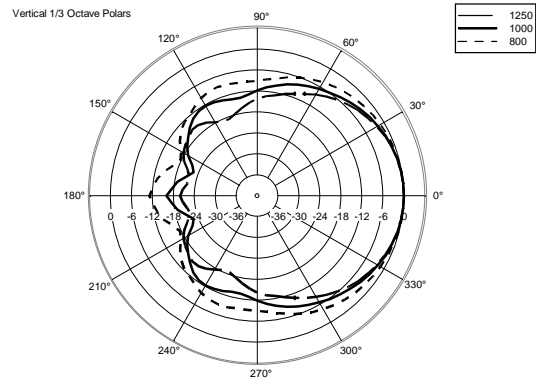
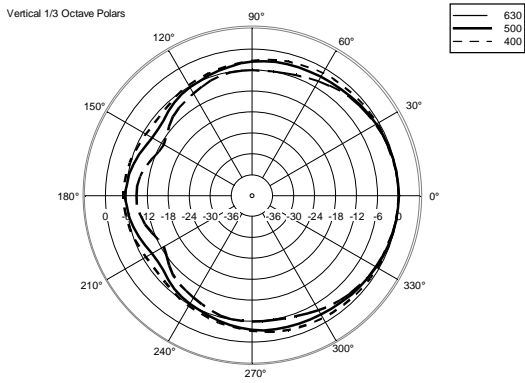
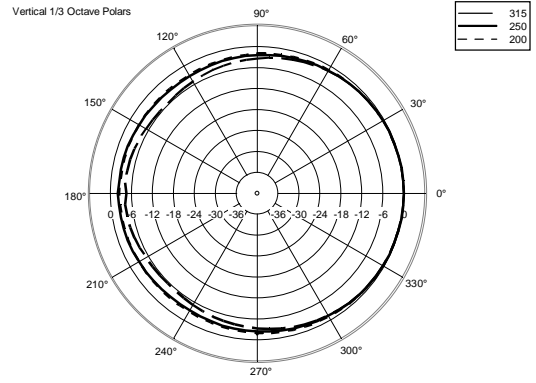
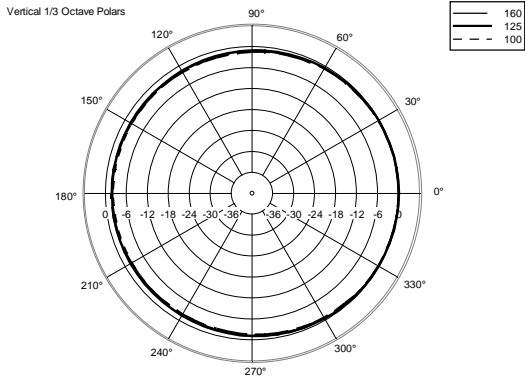

ZUBEHÖR

AC 2X AZIMUT PLATE

ARTIKEL-
NUMMER**13360351**

EAN:

8024530013516



AC POWER CABLE 6X TTL55

ARTIKEL-
NUMMER**13360138**

EAN:



AC TRUSS CLAMP HDL6

ARTIKEL-
NUMMER**13360371**

EAN:

8024530014360



CABLES KIT CBL ETHERCON 0.7M

ARTIKEL-
NUMMER**12399016**

EAN:

8024530013844



CABLES KIT CBL ETHERCON 1.5M

ARTIKEL-
NUMMER**12399017**

EAN:

8024530013851



CABLES KIT CBL ETHERCON 3M

ARTIKEL-
NUMMER**12399035**

EAN:

8024530013868



CABLES KIT CBL ETHERCON 5M

ARTIKEL-
NUMMER**12399018**

EAN:

8024530013875



CABLES KIT CBL ETHERCON TO XLR F 0.2M

ARTIKEL-
NUMMER**12399019**

EAN:

8024530013882













CABLES KIT CBL ETHERCON TO XLR M 0.2M

ARTIKEL-
NUMMER**12399020**

EAN:

8024530013899

| | | | |
|---|------------------------------------|------------------------|----------------------------------|
|  | CABLES KIT CBL LK 25 MULTIPIN 10M | ARTIKEL-NUMMER EAN: | 12399023 8024530013837 |
|  | CABLES KIT CBL LK 25 MULTIPIN 20M | ARTIKEL-NUMMER EAN: | 12399022 8024530013820 |
|  | CABLES KIT CBL LKS 19 ARRAY FANOUT | ARTIKEL-NUMMER EAN: | 12399024 8024530013905 |
|  | CABLES KIT CBL LKS 19 BREAKOUT | ARTIKEL-NUMMER EAN: | 12399026 8024530013929 |
|  | CABLES KIT CBL LKS 19 POWER 10M | ARTIKEL-NUMMER EAN: | 12399027 8024530013936 |
|  | CABLES KIT CBL LKS 19 SUB FANOUT | ARTIKEL-NUMMER EAN: | 12399025 8024530013912 |
|  | CABLES KIT CBL LKS 25-2 FANOUT | ARTIKEL-NUMMER EAN: | 12399021 8024530013813 |
|  | CABLES KIT CBL POWER BOX 6X | ARTIKEL-NUMMER EAN: | 13360145 8024530015534 |
|  | CABLES KIT CBL POWERCON LINK 0.7M | ARTIKEL-NUMMER EAN: | 12399031 8024530013738 |
|  | CABLES KIT CBL POWERCON LINK 1.5M | ARTIKEL-NUMMER EAN: | 12399030 8024530013721 |

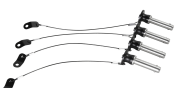
| | | | |
|---|-------------------------------------|------------------------|----------------------------------|
|  | CABLES KIT CBL POWERCON LINK 10M | ARTIKEL-NUMMER EAN: | 12399028 8024530013707 |
|  | CABLES KIT CBL POWERCON LINK 5M | ARTIKEL-NUMMER EAN: | 12399029 8024530013714 |
|  | FLY BAR FL-B HDL 6 | ARTIKEL-NUMMER EAN: | 13360360 8024530014209 |
|  | FLY BAR FL-B HDL 6 W | ARTIKEL-NUMMER EAN: | 13360373 8024530014377 |
|  | FLY BAR PICKUP FL-B PK HDL 6 | ARTIKEL-NUMMER EAN: | 13360372 8024530014353 |
|  | KART WITH WHEELS KRT-WH 6X HDL 6 | ARTIKEL-NUMMER EAN: | 13360366 8024530014421 |
|  | LINK BAR FL-B LINK HDL 6-12 2X | ARTIKEL-NUMMER EAN: | 13360375 8024530014414 |
|  | LKS 19-20 POWER CABLE | ARTIKEL-NUMMER EAN: | 13360146 8024530013943 |
|  | POLE MOUNT 3X HDL 6-A | ARTIKEL-NUMMER EAN: | 13360377 8024530014629 |
|  | QUICK LOCK PIN QL-PIN D9.6 L21.3 4X | ARTIKEL-NUMMER EAN: | 13360219 8024530015763 |



RAIN PROTECTION RP 1X HDL 6

ARTIKEL-
NUMMER

13360381

EAN:

8024530015169
