

5 APPENDIX
5.1 PARTS DIAGRAM

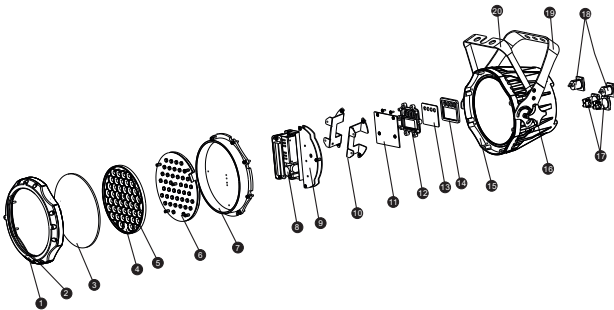

No	ITEM	No	ITEM
1	Front cover	10	Display PCB
2	Rubber seal	11	Display clear plate
3	Clear glass	12	Button seal
4	Lens completed set	13	Casing
5	LED PCB	14	Adjusting stainless steel knob
6	Heat sink	15	Power cable socket
7	Power supply	16	DMX cable socket
8	Driver PCB	17	Main support
9	Power connection board	18	Secondary support

EXPOLITE

TourLED 42 CM MKII

Bedienungsanleitung

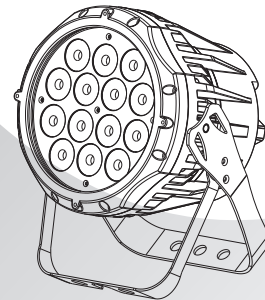

IP20: led22309
IP67: led22308

1 Allgemeine Produktinformationen

1.1 Technische Daten

LED MODULE

Type	Model	Spannung	Umgebungs Temperatur	kg	Abmessungen in mm	Leistg in W	IP
φ	R:3Wx14 G:3Wx14 B:3Wx14	AC100~240V 50/60Hz	-20~45	4.8	245x205x245	50	IP2X
φ	R:3Wx14 G:3Wx14 B:3Wx14						IP66

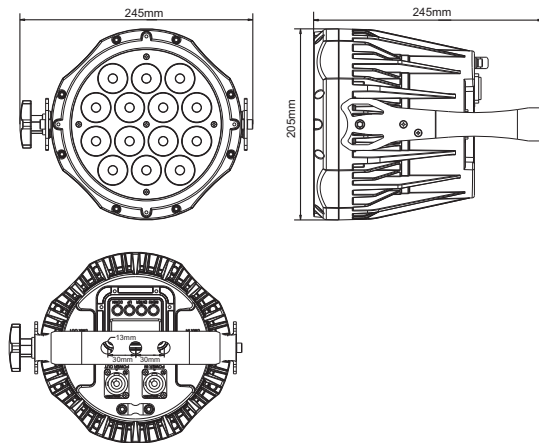

D 02

ARC.1

CHANNEL	VALUE	FUNCTION
1	0 ↔ 255	RED
2	0 ↔ 255	GREEN
3	0 ↔ 255	BLUE

AR1.d

CHANNEL	VALUE	FUNCTION
1	0 ↔ 255	DIMMER
2	0 ↔ 255	RED
3	0 ↔ 255	GREEN
4	0 ↔ 255	BLUE

AR1.S

CHANNEL	VALUE	FUNCTION
1	0 ↔ 255	DIMMER
2	0 ↔ 255	RED
3	0 ↔ 255	GREEN
4	0 ↔ 255	BLUE
5	0 ↔ 255	STROBE

HSV

CHANNEL	VALUE	FUNCTION
1	0 ↔ 255	HUE
2	0 ↔ 255	SATURATION
3	0 ↔ 255	VALUE

E 17

CHANNEL	VALUE	FUNCTION
11		AUTO
	0 ↔ 20	NO FUNCTION
	21 ↔ 30	AUTO01
	31 ↔ 40	AUTO02
	41 ↔ 50	AUTO03
	51 ↔ 60	AUTO04
	61 ↔ 70	AUTO05
	71 ↔ 80	AUTO06
	81 ↔ 90	AUTO07
	91 ↔ 100	AUTO08
	101 ↔ 110	AUTO09
	111 ↔ 120	AUTO10
	121 ↔ 130	CUSTOM01
	131 ↔ 140	CUSTOM02
	141 ↔ 150	CUSTOM03
	151 ↔ 160	CUSTOM04
	161 ↔ 170	CUSTOM05
	171 ↔ 180	CUSTOM06
	181 ↔ 190	CUSTOM07
	191 ↔ 200	CUSTOM08
	201 ↔ 210	CUSTOM09
	211 ↔ 220	CUSTOM10
221 ↔ 255	NO FUNCTION	
12		AUTO SPEED
	0 ↔ 255	Since the walking speed (slow to fast)
13		DIMMER SPEED
	0 ↔ 9	RETURN SETTINGS
	10 ↔ 29	NORMAL
	30 ↔ 69	DIM 1
	70 ↔ 129	DIM 2
	130 ↔ 189	DIM 3
	190 ↔ 255	DIM 4

1.2 SICHERHEITSHINWEISE

WICHTIG!

Dieses Produkt darf nur von qualifiziertem Fachpersonal installiert werden

Arbeiten am Gerät dürfen nur von qualifizierten Servicekräften vorgenommen werden

Ein Mindestabstand von 0.5m zur nächsten Oberfläche muss eingehalten werden

Das Produkt darf nur in gut belüfteten Räumen betrieben werden

Nie direkt in die Lichtquelle schauen

Immer die Spannungsversorgung trennen bevor Arbeiten an dem Gerät durchgeführt werden

Der Schutzleiter muss immer verbunden sein

Es muss Gewährleistet werden, dass das Gerät nicht verschmutzt ist

Achtung: Erstickungsgefahr durch Kunststofffüten

2 INSTALLATION

2.1 Befestigung

Hängend

Das Gerät kann an dem Haltebügel hängend montiert werden. Hierzu muss eine geeignete Befestigung wie eine Traversenschelle benutzt werden. Bitte achten Sie auf geltende Vorschriften zur Sicherung wie das Anschlagen eines Sicherungsseiles.



Stehend

Das Gerät kann durch aufklappen des Bügels sicher aufgestellt werden.

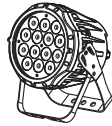

Das LED-Modul kann in jeder beliebigen Position montiert werden. Die Neigung im Bügel kann bequem durch lösen der Arretierschraube verstellt werden.

2.2 Spannungsversorgung

@ 230V: Maximal 24 Geräte in Reihe

@120V: Maximal 12 Geräte in Reihe

CHANNEL	VALUE	FUNCTION
10		SPECIAL STROBE
	0 ↔ 9	No strobe
	10 ↔ 99	Strobe (slow to fast)
	100 ↔ 109	No strobe
	110 ↔ 179	Lightning strobe (slow to fast)
	180 ↔ 189	No strobe
	190 ↔ 255	Random strobe (slow to fast)
		CLASSIC STROBE
	0 ↔ 9	0
	10 ↔ 19	1
	20 ↔ 29	2
	30 ↔ 39	3
	40 ↔ 49	4
	50 ↔ 59	5
	60 ↔ 69	6
	70 ↔ 79	7
	80 ↔ 89	8
	90 ↔ 99	9
	100 ↔ 109	10
	110 ↔ 119	11
120 ↔ 129	12	
130 ↔ 139	13	
140 ↔ 149	14	
150 ↔ 159	15	
160 ↔ 169	16	
170 ↔ 179	17	
180 ↔ 189	18	
190 ↔ 199	19	
200 ↔ 255	20	

TR16

CHANNEL	VALUE	FUNCTION
1	0 ↔ 255	MASTER DIMMER
2	0 ↔ 255	MASTER DIMMER FINE
3	0 ↔ 255	RED ECH11 SELECT CUSTOM 01-10ECH3 CONTROL TIME
4	0 ↔ 255	RED FINE ECH11 SELECT CUSTOM 01-10ECH4 CONTROL FADEE
5	0 ↔ 255	GREEN
6	0 ↔ 255	GREEN FINE
7	0 ↔ 255	BLUE
8	0 ↔ 255	BLUE FINE
9		COLOR MACRO & WHITE
	0 ↔ 10	NO FUNCTION
	11 ↔ 30	RED 100% / GREEN UP / BLUE 0%
	31 ↔ 50	RED DOWN / GREEN 100% / BLUE 0%
	51 ↔ 70	RED 0% / GREEN 100% / BLUE UP
	71 ↔ 90	RED 0% / GREEN DOWN / BLUE 100%
	91 ↔ 110	RED UP / GREEN 0% / BLUE 100%
	111 ↔ 130	RED 100% / GREEN 0% / BLUE DOWN
	131 ↔ 150	RED 100% / GREEN UP / BLUE UP
	151 ↔ 170	RED DOWN / GREEN DOWN / BLUE 100%
	171 ↔ 200	RED 100% / GREEN 100% / BLUE 100% / WHITE 100%
	201 ↔ 205	WHITE1E3200K
	206 ↔ 210	WHITE2E3400K
	211 ↔ 215	WHITE3E4200K
	216 ↔ 220	WHITE4E4900K
	221 ↔ 225	WHITE5E5600K
	226 ↔ 230	WHITE6E5900K
	231 ↔ 235	WHITE7E6500K
	236 ↔ 240	WHITE8E7200K
	241 ↔ 245	WHITE9E8000K
246 ↔ 250	WHITE10E8500K	
251 ↔ 255	WHITE11E10000K	

2.3 Betrieb mit einem DMX512 Controller

Den Controller mit den Geräten verbinden
 Die Startadressen entsprechend der eingestellten Personality einstellen
 Die Geräte ID muss im Menü auf OFF gestellt werden
 DMX-Adressen können mehrfach vergeben werden

Beispiel:

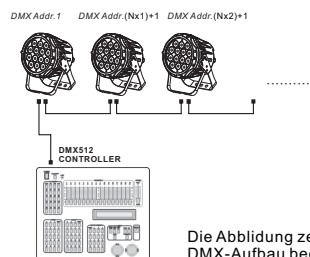

Die Abbildung zeigt einen einfachen DMX-Aufbau beginnend mit der Startadresse 1

3 Einstellungen im Displaymenü

3.1 DISPLAY BEDIENUNG

- [MENU] Weiter zum nächsten Menü.
- [ENTER] Auswahl des aktuellen Punktes.
- [UP] Scrollen durch das Menü oder erhöhen von Werten.
- [DOWN] Scrollen durch das Menü oder senken von Werten.

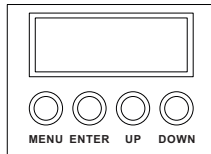

3.2 Menüstruktur

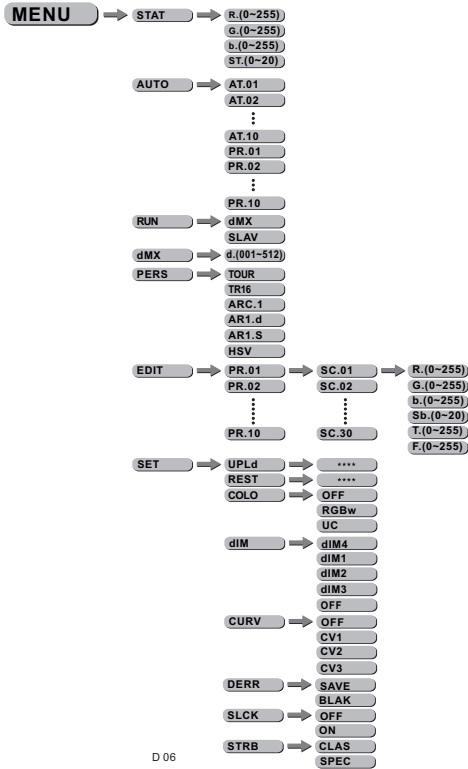

D 06

CHANNEL	VALUE	FUNCTION
7		AUTO
	0 ⇄ 20	NO FUNCTION
	21 ⇄ 30	AUTO01
	31 ⇄ 40	AUTO02
	41 ⇄ 50	AUTO03
	51 ⇄ 60	AUTO04
	61 ⇄ 70	AUTO05
	71 ⇄ 80	AUTO06
	81 ⇄ 90	AUTO07
	91 ⇄ 100	AUTO08
	101 ⇄ 110	AUTO09
	111 ⇄ 120	AUTO10
	121 ⇄ 130	CUSTOM01
	131 ⇄ 140	CUSTOM02
	141 ⇄ 150	CUSTOM03
	151 ⇄ 160	CUSTOM04
	161 ⇄ 170	CUSTOM05
	171 ⇄ 180	CUSTOM06
	181 ⇄ 190	CUSTOM07
	191 ⇄ 200	CUSTOM08
	201 ⇄ 210	CUSTOM09
	211 ⇄ 220	CUSTOM10
221 ⇄ 255	NO FUNCTION	
8		AUTO SPEED
	0 ⇄ 255	Since the walking speed (slow to fast)
9		DIMMER SPEED
	0 ⇄ 9	RETURN SETTINGS
	10 ⇄ 29	NORMAL
	30 ⇄ 69	DIM 1
	70 ⇄ 129	DIM 2
	130 ⇄ 189	DIM 3
190 ⇄ 255	DIM 4	

E 13

CHANNEL	VALUE	FUNCTION
6		SPECIAL STROBE
	0 ↔ 9	No strobe
	10 ↔ 99	Strobe (slow to fast)
	100 ↔ 109	No strobe
	110 ↔ 179	Lightning strobe (slow to fast)
	180 ↔ 189	No strobe
	190 ↔ 255	Random strobe (slow to fast)
		CLASSIC STROBE
	0 ↔ 9	0
	10 ↔ 19	1
	20 ↔ 29	2
	30 ↔ 39	3
	40 ↔ 49	4
	50 ↔ 59	5
	60 ↔ 69	6
	70 ↔ 79	7
	80 ↔ 89	8
	90 ↔ 99	9
	100 ↔ 109	10
	110 ↔ 119	11
	120 ↔ 129	12
130 ↔ 139	13	
140 ↔ 149	14	
150 ↔ 159	15	
160 ↔ 169	16	
170 ↔ 179	17	
180 ↔ 189	18	
190 ↔ 199	19	
200 ↔ 255	20	

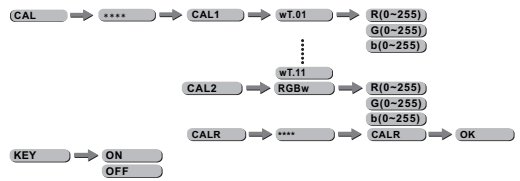

3.3 Einstellen statischer Farben

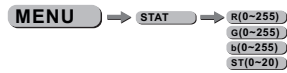

- Es kann eine beliebige Farbe aus Rot, Grün und Blau gemischt werden. Die Wertescale folgt den DMX-Werten (0-255)
- Es kann eine Stroboskopfunktion eingestellt werden **【Strobe】** (0-20Hz)

3.4 Aktivieren der Automatikprogramme

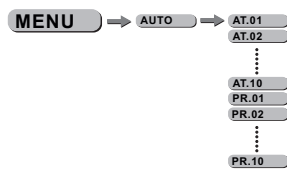

Die Programme AT01 - AT10 sind fest im Gerät hinterlegt und können nicht im Menüpunkt EDIT geändert werden. Die Programme PR01-PR10 sind vom Benutzer im Menüpunkt EDIT frei programmierbar.

3.5 RUN Modus



Wählen Sie zwischen DMX oder Slave-Modus

3.6 DMX512 Einstellungen



Die gewünschte DMX-Adresse einstellen

3.7 PERSONALITY

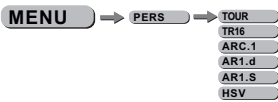

Die gewünschte DMX-Personality einstellen

3.8 Editieren der Benutzerprogramme

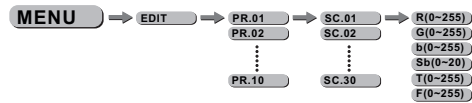

Im Editbereich das Programm auswählen Pr01 - PR10
Jedes Programm besteht aus 30 Schritten
Editierbare Parameter: Rot; Grün; Blau; Weiß; Strobe; Zeit; Fade

4 USING A DMX512 CONTROLLER

4.1 CHANNEL ASSIGNMENT

Note: This product have eleven DMX512 channel configuration: TOUR / TR16 / ARC1 / AR1.d / AR1.S / HSV

TOUR		
CHANNEL	VALUE	FUNCTION
1	0 ↔ 255	MASTER DIMMER
2	0 ↔ 255	RED ECH7 SELECT CUSTOM 01-10ECH2 CONTROL TIMEE
3	0 ↔ 255	GREENECH7 SELECT CUSTOM 01-10ECH3 CONTROL FADEE
4	0 ↔ 255	BLUE
5		COLOR MACRO & WHITE
	0 ↔ 10	NO FUNCTION
	11 ↔ 30	RED 100% / GREEN UP / BLUE 0%
	31 ↔ 50	RED DOWN / GREEN 100% / BLUE 0%
	51 ↔ 70	RED 0% / GREEN 100% / BLUE UP
	71 ↔ 90	RED 0% / GREEN DOWN / BLUE 100%
	91 ↔ 110	RED UP / GREEN 0% / BLUE 100%
	111 ↔ 130	RED 100% / GREEN 0% / BLUE DOWN
	131 ↔ 150	RED 100% / GREEN UP / BLUE UP
	151 ↔ 170	RED DOWN / GREEN DOWN / BLUE 100%
	171 ↔ 200	RED 100% / GREEN 100% / BLUE 100% / WHITE 100%
	201 ↔ 205	WHITE1E3200K
	206 ↔ 210	WHITE2E3400K
	211 ↔ 215	WHITE3E4200K
	216 ↔ 220	WHITE4E4900K
	221 ↔ 225	WHITE5E5600K
	226 ↔ 230	WHITE6E5900K
231 ↔ 235	WHITE7E6500K	
236 ↔ 240	WHITE8E7200K	
241 ↔ 245	WHITE9E8000K	
246 ↔ 250	WHITE10E8500K	
251 ↔ 255	WHITE11E10000K	

CURV dimming

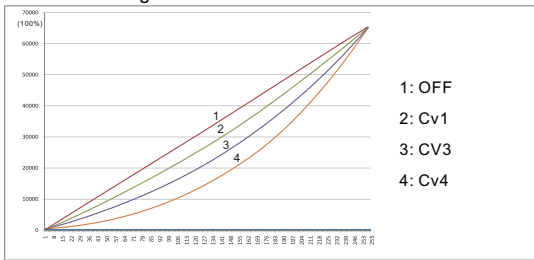

3.10 BALANCE PARAMETERS AND CORRECTION MENU DISPLAY

Press **MENU** button to enter the password confirmation, to enter the correct password < UP + DOWN + UP + DOWN > Key, press the **MENU** in, the correct password will enter show submenu

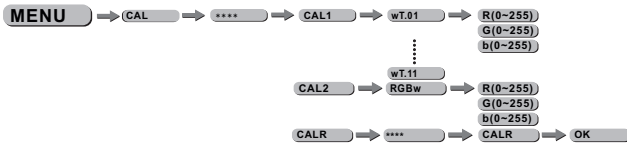

- Enter the **CAL1** to select white color of different color temperature.
- There are 11 pre-programmed White colors can be edited by using **Red**, **Green** & **Blue**.
- Enter the **CAL2** to adjust the RGB parameter to make different whites.
- When the new setting is activated, the DMX controller choose RGB = 255,255,255 the white color will be made by the actual RGB values on the **CAL2**.

3.11 ACTIVATE THE PASSWORD



- Enter the **KEY** mode to select whether the access password is on or off.
- When the fixture is set as PASS **ON**, after 30 seconds or turn on the fixture next time, the fixture will need an access password to enter the display menu control.

Note: The factory access password is **UP+DOWN+UP+DOWN**, then press **ENTER** to confirm the access.

3.9 Zusatzeinstellungen

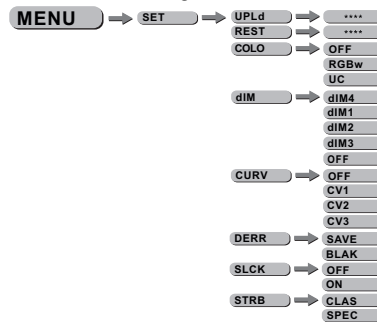

- [SET] In diesem Menü sind Zusatzfunktionen hinterlegt
- [UPLD] Übertragen von Benutzerprogrammen auf Slave-Geräte
- [REST] Reset
- [COLR] Farbkalibrierung
- [DIM1], [DIM2], [DIM3] oder [DIM4] Dimmergeschwindigkeiten für Halogensimulation ([DIM4]=langsam)
- [DERR] DMX-Fehlverhalten. Letztes Signal beibehalten oder abdimmern
- [ZOOM] Festlegen der Start- und Endposition des Zooms
- [CURV] Einstellen der Dimmerkurve

CURV dimming

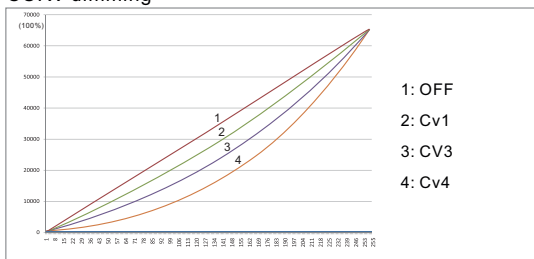

3.10 Weißabgleich und Kalibrierung

Um in das Kalibrierungsmenü zu gelangen muss das Passwort < UP + DOWN + UP + DOWN > eingegeben werden

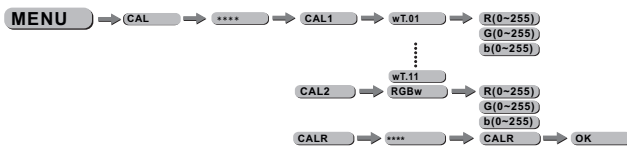

Im CAL1 Menü werden die 11 hinterlegten Weißwerte verändert

Im CAL2 Menü werden die Maximalwerte festgelegt, die bei dem DMX-Wert 255 der jeweiligen Farbe dargestellt werden.

3.11 Passwortschutz



Aktiviert den Passwortschutz für Veränderungen im Menü

Hinweis: Das Fabrikpasswort ist UP+DOWN+UP+DOWN

3.9 SPECIAL SETTINGS

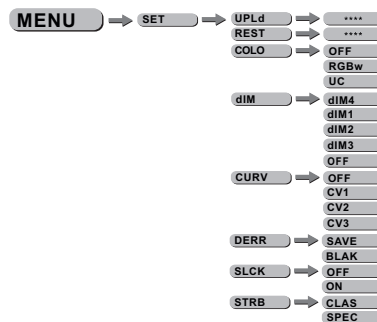

- i Select [UPLD] to upload the custom programs from the current MASTER unit to the SLAVE units.
- i In order to reset custom modes to default values select [REST].
- i [COLO] is for activate/unactivate the color calibration functions. When [RGBW] is selected, on RGB = 255,255,255, the color is displayed as calibrated in CAL2 -- RGBW. When [COLR] is set [OFF], on RGB = 255,255,255, the RGB values are not adjusted and the output is most powerful. When [UC] is selected, the RGB output are adjusted to a standard preset universal color which balances fixtures from different generations.
- i Select [DIM1], [DIM2], [DIM3] or [DIM4] for different dimming speeds. ([DIM4] is the slowest dimming speed)
- i [CURV] allows the user to adjust the shape of the dimming curve. See the CURV chart to understand more about actual dimming curves.
- i [DERR] Choose [Save] in order to save the last DMX data in case of DMX signal error. Choose [Black] in order to blackout in case of DMX signal error.
- i [SLCK] is used to lock the settings menu. When [SLCK] is set to [ON] then user must insert passcode (UP+DOWN+UP+DOWN) in order to access the settings menu.
- i [STRB] This fixture allows for two different strobe personality settings, [CLAS] strobe or [SPEC] strobe. The [STRB] settings are only valid in the DMX personalities [TOUR], [AR2.S] and [TR16]

3.6 DMX512 SETTINGS



Enter the **dMX** mode to set the DMX ADDRESS.

3.7 PERSONALITY

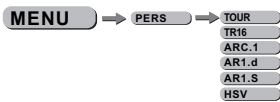

Enter the **PERSONALITY** mode to select DMX mode: **TOUR**, **TR16**, **ARC.1**, **AR1.d**, **AR1.S**, **HSV**

3.8 EDITING CUSTOM PROGRAMS

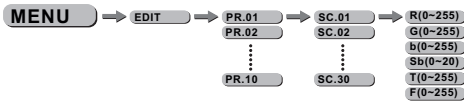

Enter the **EDIT** mode to edit the custom programs **PR.01** to **PR.10**.
 Each custom program has 30 steps that can be edited.
 Each step allows the creation of a scene using **RED**, **GREEN**, **BLUE**, **STRB**, **TIME** & **FADE**.

4 Steuerung über DMX-512

4.1 Kanalbelegung

Hinweis: Dieses Gerät verfügt über verschiedene DMX-Modi die im Menü Personality eingestellt werden können.

TOUR		
CHANNEL	VALUE	FUNCTION
1	0 ↔ 255	MASTER DIMMER
2	0 ↔ 255	RED ECH7 SELECT CUSTOM 01-10 ECH2 CONTROL TIME
3	0 ↔ 255	GREEN ECH7 SELECT CUSTOM 01-10 ECH3 CONTROL FADE
4	0 ↔ 255	BLUE
		COLOR MACRO & WHITE
	0 ↔ 10	NO FUNCTION
	11 ↔ 30	RED 100% / GREEN UP / BLUE 0%
	31 ↔ 50	RED DOWN / GREEN 100% / BLUE 0%
	51 ↔ 70	RED 0% / GREEN 100% / BLUE UP
	71 ↔ 90	RED 0% / GREEN DOWN / BLUE 100%
	91 ↔ 110	RED UP / GREEN 0% / BLUE 100%
	111 ↔ 130	RED 100% / GREEN 0% / BLUE DOWN
	131 ↔ 150	RED 100% / GREEN UP / BLUE UP
	151 ↔ 170	RED DOWN / GREEN DOWN / BLUE 100%
	171 ↔ 200	RED 100% / GREEN 100% / BLUE 100% / WHITE 100%
5	201 ↔ 205	WHITE 1E3200K
	206 ↔ 210	WHITE 2E3400K
	211 ↔ 215	WHITE 3E4200K
	216 ↔ 220	WHITE 4E4900K
	221 ↔ 225	WHITE 5E5600K
	226 ↔ 230	WHITE 6E5900K
	231 ↔ 235	WHITE 7E6500K
	236 ↔ 240	WHITE 8E7200K
	241 ↔ 245	WHITE 9E8000K
	246 ↔ 250	WHITE 10E8500K
	251 ↔ 255	WHITE 11E10000K

CHANNEL	VALUE	FUNCTION
6		SPECIAL STROBE
	0 ⇄ 9	No strobe
	10 ⇄ 99	Strobe (slow to fast)
	100 ⇄ 109	No strobe
	110 ⇄ 179	Lightning strobe (slow to fast)
	180 ⇄ 189	No strobe
	190 ⇄ 255	Random strobe (slow to fast)
		CLASSIC STROBE
	0 ⇄ 9	0
	10 ⇄ 19	1
	20 ⇄ 29	2
	30 ⇄ 39	3
	40 ⇄ 49	4
	50 ⇄ 59	5
	60 ⇄ 69	6
	70 ⇄ 79	7
	80 ⇄ 89	8
	90 ⇄ 99	9
	100 ⇄ 109	10
	110 ⇄ 119	11
120 ⇄ 129	12	
130 ⇄ 139	13	
140 ⇄ 149	14	
150 ⇄ 159	15	
160 ⇄ 169	16	
170 ⇄ 179	17	
180 ⇄ 189	18	
190 ⇄ 199	19	
200 ⇄ 255	20	

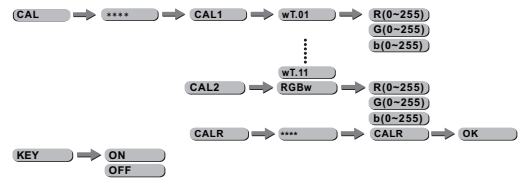

3.3 EDIT STATIC COLOUR



- Combine *Red*, *Green* and *Blue* to create an infinite range of colors (0-255)
- Set the value of the *Strobe* (0-20Hz)

3.4 ACTIVATING AUTO PROGRAMS

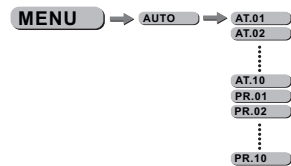

- Select the target *AUTO* program and press *ENTER*.
- Programs *AT.01* to *AT.10* are fully pre-programmed and will not be altered by changes in *EDIT* mode.
- Programs *PR.01* to *PR.10* are fully pre-programmed and can be edited in *EDIT* mode.

3.5 RUN MODE



- Enter the *RUN* mode to set working mode.
- DMX* mode is for using the DMX512 controller to control the fixtures.
- SLAV* mode is for Master -- Slave operation.

3 DISPLAY PANEL OPERATION

3.1 DISPLAY OPERATION

- 【 MENU 】 return to the previous menu.
- 【 ENTER 】 enter the currently selected menu.
- 【 UP 】 scroll down through the current menu list or decrease the value of the current function.
- 【 DOWN 】 scroll up through the current menu list or increase the value of the current function.

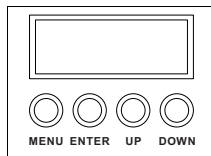

3.2 MENU MAP

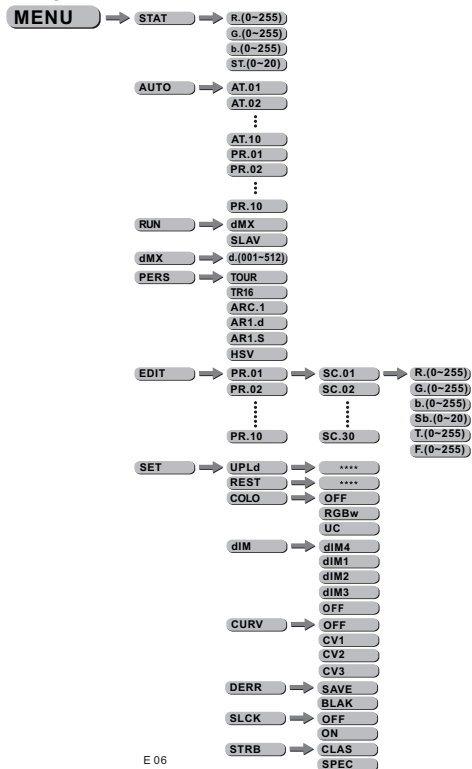

E 06

CHANNEL	VALUE	FUNCTION
7		AUTO
	0 ↔ 20	NO FUNCTION
	21 ↔ 30	AUTO01
	31 ↔ 40	AUTO02
	41 ↔ 50	AUTO03
	51 ↔ 60	AUTO04
	61 ↔ 70	AUTO05
	71 ↔ 80	AUTO06
	81 ↔ 90	AUTO07
	91 ↔ 100	AUTO08
	101 ↔ 110	AUTO09
	111 ↔ 120	AUTO10
	121 ↔ 130	CUSTOM01
	131 ↔ 140	CUSTOM02
	141 ↔ 150	CUSTOM03
	151 ↔ 160	CUSTOM04
	161 ↔ 170	CUSTOM05
	171 ↔ 180	CUSTOM06
	181 ↔ 190	CUSTOM07
	191 ↔ 200	CUSTOM08
	201 ↔ 210	CUSTOM09
	211 ↔ 220	CUSTOM10
221 ↔ 255	NO FUNCTION	
8		AUTO SPEED
	0 ↔ 255	Since the walking speed (slow to fast)
9		DIMMER SPEED
	0 ↔ 9	RETURN SETTINGS
	10 ↔ 29	NORMAL
	30 ↔ 69	DIM 1
	70 ↔ 129	DIM 2
	130 ↔ 189	DIM 3
	190 ↔ 255	DIM 4

D 13

TR16

CHANNEL	VALUE	FUNCTION
1	0 ↔ 255	MASTER DIMMER
2	0 ↔ 255	MASTER DIMMER FINE
3	0 ↔ 255	RED ECH11 SELECT CUSTOM 01-10ECH3 CONTROL TIMEE
4	0 ↔ 255	RED FINEECH11 SELECT CUSTOM 01-10ECH4 CONTROL FADEE
5	0 ↔ 255	GREEN
6	0 ↔ 255	GREEN FINE
7	0 ↔ 255	BLUE
8	0 ↔ 255	BLUE FINE
9		COLOR MACRO & WHITE
	0 ↔ 10	NO FUNCTION
	11 ↔ 30	RED 100% / GREEN UP / BLUE 0%
	31 ↔ 50	RED DOWN / GREEN 100% / BLUE 0%
	51 ↔ 70	RED 0% / GREEN 100% / BLUE UP
	71 ↔ 90	RED 0% / GREEN DOWN / BLUE 100%
	91 ↔ 110	RED UP / GREEN 0% / BLUE 100%
	111 ↔ 130	RED 100% / GREEN 0% / BLUE DOWN
	131 ↔ 150	RED 100% / GREEN UP / BLUE UP
	151 ↔ 170	RED DOWN / GREEN DOWN / BLUE 100%
	171 ↔ 200	RED 100% / GREEN 100% / BLUE 100% / WHITE 100%
	201 ↔ 205	WHITE1 : 3200K
	206 ↔ 210	WHITE2 : 3400K
	211 ↔ 215	WHITE3 : 4200K
	216 ↔ 220	WHITE4 : 4900K
	221 ↔ 225	WHITE5 : 5600K
	226 ↔ 230	WHITE6 : 5900K
	231 ↔ 235	WHITE7 : 6500K
	236 ↔ 240	WHITE8 : 7200K
	241 ↔ 245	WHITE9 : 8000K
246 ↔ 250	WHITE10 : 8500K	
251 ↔ 255	WHITE11 : 10000K	

2.3 SETTING UP WITH A DMX512 CONTROLLER

- i Connect the DMX512 controller to the units in series.
- i Each unit has 13 DMX channels so the DMX Addresses should increase by increments of 1 ((Nx1)+1 (Nx2)+1 (Nx3)+1)
- i The ID address has not been set so therefore when using the controller CH 10 must be inactive (CH10=0).
- i It is also possible to deactivate ID address selecting **ID OFF** from the **Settings** menu. on the fixture
- i Each DMX Address may be used as many times as required.
- i Any DMX address in the range from 001 to 512 may be used.

Example:

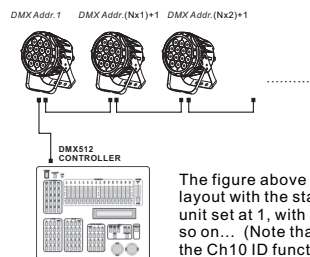

The figure above shows a simple DMX512 layout with the starting address of the first unit set at 1, with the second set at (Nx1)+1 and so on... (Note that when used in this way, the Ch10 ID function must be inactive (CH10=0))

2 INSTALLATION

2.1 MOUNTING

HANGING

The fixture can be mounted in a hanging position using the supporting bracket. The bracket should be secured to the mounting truss or structure using a standard mounting clamp. Please note that when hanging the unit a safety cable should also be used.



UPRIGHT

The fixture can be mounted in an upright or sitting position using the supporting brackets.

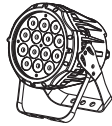

NOTE The LED MODULE can be mounted at any angle and in any position. It is possible to further adjust the angle of the LED MODULE using the two adjustment knobs located on the side of the fixture.

2.2 POWER CONNECTIONS

@ 220V: 24 units may be connected in series

@ 120V: 12 units may be connected in series

CHANNEL	VALUE	FUNCTION
10		SPECIAL STROBE
	0 ↔ 9	No strobe
	10 ↔ 99	Strobe (slow to fast)
	100 ↔ 109	No strobe
	110 ↔ 179	Lightning strobe (slow to fast)
	180 ↔ 189	No strobe
	190 ↔ 255	Random strobe (slow to fast)
		CLASSIC STROBE
	0 ↔ 9	0
	10 ↔ 19	1
	20 ↔ 29	2
	30 ↔ 39	3
	40 ↔ 49	4
	50 ↔ 59	5
	60 ↔ 69	6
	70 ↔ 79	7
	80 ↔ 89	8
	90 ↔ 99	9
	100 ↔ 109	10
	110 ↔ 119	11
120 ↔ 129	12	
130 ↔ 139	13	
140 ↔ 149	14	
150 ↔ 159	15	
160 ↔ 169	16	
170 ↔ 179	17	
180 ↔ 189	18	
190 ↔ 199	19	
200 ↔ 255	20	

CHANNEL	VALUE	FUNCTION
11		AUTO
	0 ⇄ 20	NO FUNCTION
	21 ⇄ 30	AUTO01
	31 ⇄ 40	AUTO02
	41 ⇄ 50	AUTO03
	51 ⇄ 60	AUTO04
	61 ⇄ 70	AUTO05
	71 ⇄ 80	AUTO06
	81 ⇄ 90	AUTO07
	91 ⇄ 100	AUTO08
	101 ⇄ 110	AUTO09
	111 ⇄ 120	AUTO10
	121 ⇄ 130	CUSTOM01
	131 ⇄ 140	CUSTOM02
	141 ⇄ 150	CUSTOM03
	151 ⇄ 160	CUSTOM04
	161 ⇄ 170	CUSTOM05
	171 ⇄ 180	CUSTOM06
	181 ⇄ 190	CUSTOM07
	191 ⇄ 200	CUSTOM08
	201 ⇄ 210	CUSTOM09
	211 ⇄ 220	CUSTOM10
221 ⇄ 255	NO FUNCTION	
12		AUTO SPEED
	0 ⇄ 255	Since the walking speed (slow to fast)
13		DIMMER SPEED
	0 ⇄ 9	RETURN SETTINGS
	10 ⇄ 29	NORMAL
	30 ⇄ 69	DIM 1
	70 ⇄ 129	DIM 2
	130 ⇄ 189	DIM 3
	190 ⇄ 255	DIM 4

1.2 SAFETY WARNING

IMPORTANT

iThis product must be installed by a qualified professional.

iAll maintenance must be carried out by a qualified electrician.

iA minimum distance of 0.5m must be maintained between the equipment and a combustible surface.

iThe product must always be operated in a well ventilated area.

iDO NOT stare directly into the LED light source.

iAlways disconnect the power before carrying out any maintenance.

iThe earth must always be connected to the ground.

iEnsure that all parts of the equipment are kept clean and free of dust.

1 PRODUCT (GENERAL)

1.1 TECHNICAL SPECIFICATIONS

LED MODULE

Type	Model	Voltage	Operation Temperature	Weight	Dimensions 2 mm±	Power W±	IP
C	R:3Wx14 G:3Wx14 B:3Wx14	AC100~240V 50/60Hz	-20~45	4.8	245x205x245	50	IP2X
C	R:3Wx14 G:3Wx14 B:3Wx14						IP66

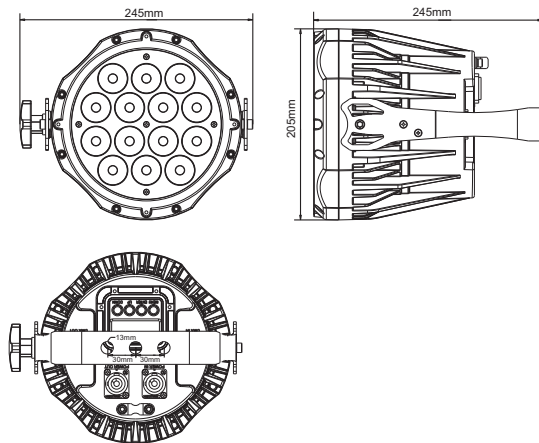

E 02

ARC.1

CHANNEL	VALUE	FUNCTION
1	0 ⇄ 255	RED
2	0 ⇄ 255	GREEN
3	0 ⇄ 255	BLUE

AR1.d

CHANNEL	VALUE	FUNCTION
1	0 ⇄ 255	DIMMER
2	0 ⇄ 255	RED
3	0 ⇄ 255	GREEN
4	0 ⇄ 255	BLUE

AR1.S

CHANNEL	VALUE	FUNCTION
1	0 ⇄ 255	DIMMER
2	0 ⇄ 255	RED
3	0 ⇄ 255	GREEN
4	0 ⇄ 255	BLUE
5	0 ⇄ 255	STROBE

HSV

CHANNEL	VALUE	FUNCTION
1	0 ⇄ 255	HUE
2	0 ⇄ 255	SATURATION
3	0 ⇄ 255	VALUE

D 17

5 Anhang

5.1 Explosionszeichnung

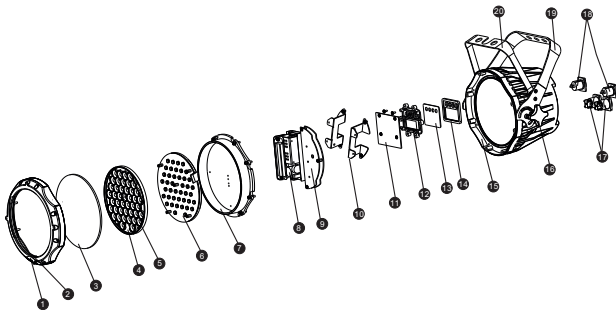

No	ITEM	No	ITEM
1	Front cover	10	Display PCB
2	Rubber seal	11	Display clear plate
3	Clear glass	12	Button seal
4	Lens completed set	13	Casing
5	LED PCB	14	Adjusting stainless steel knob
6	Heat sink	15	Power cable socket
7	Power supply	16	DMX cable socket
8	Driver PCB	17	Main support
9	Power connection board	18	Secondary support

EXPOLITE

TourLED 42 CM MKII

User Manual

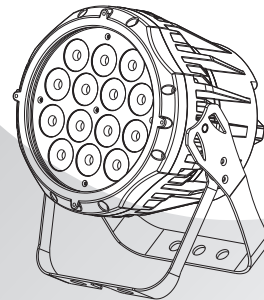

IP20: led22309
IP67: led22308